

























ODKVAPOVÝ SYSTÉM

CENNÍK

				POVRCHOVÁ ÚPRAVA				
				Pozink. plech +Akzonobel		Aluzinok - prírodný		
		MJ	rozmer	€/MJ bez DPH	€/MJ s DPH	€/MJ bez DPH	€/MJ sDPH	
ŽLAB POD ODKVAPOVÝ L=2000/4000mm		B01	bm	125	4,00	4,80	2,16	2,59
				150	4,60	5,52	2,86	3,43
ŽLABOVÝ ROH VNÚTORNÝ 90°		B02	ks	125	8,45	10,14	4,23	5,08
				150	8,61	10,33	5,82	6,98
ŽLABOVÝ ROH VONKAJŠÍ 90°		B03	ks	125	8,45	10,14	4,23	5,08
				150	8,61	10,33	5,82	6,98
ŽLABOVÉ ČELO DOPREDAJ*		B04	ks	125	1,93	2,32	0,96	1,15
				150	2,03	2,44	1,30	1,56
ŽLABOVÉ ČELO MASLEN		B04	ks	125	1,35	1,62	0,95	1,14
				150	1,40	1,68	1,00	1,20
ŽLABOVÝ HÁK L=330mm DOPREDAJ*		B06	ks	125	2,35	2,82	1,90	2,28
				150	2,75	3,30	2,35	2,82
ŽLABOVÝ HÁK s nosom L=300mm		B06N	ks	125	2,00	2,40	1,55	1,86
				150	2,40	2,88	2,00	2,40
ŽLABOVÝ HÁK s nosom L=350mm		B06N	ks	125	2,40	2,88	1,85	2,22
				150	2,80	3,36	2,30	2,76
ŽLABOVÝ HÁK s plieškom L=300mm		B06P	ks	125	2,25	2,70	1,90	2,28
				150	2,65	3,18	2,35	2,82
ŽLABOVÝ HÁK s plieškom L=350mm		B06P	ks	125	2,65	3,18	2,10	2,52
				150	3,05	3,66	2,55	3,06
ŽLABOVÝ HÁK MASLEN do čelovej dosky		B10	ks	125	1,60	1,92	1,40	1,68
				150	2,00	2,40	1,70	2,04
ŽLABOVÝ HÁK MASLEN s nosom do čelovej dosky			ks	125	1,50	1,80	1,30	1,56
				150	1,90	2,28	1,60	1,92
ŽLABOVÝ HÁK KOMPAKT na odkvap. dosku DOPREDAJ*		B10	ks	125	2,02	2,42	1,65	1,98
				150	2,43	2,92	2,21	2,65
ŽLABOVÁ SPOJKA		B11	ks	125	2,05	2,46	1,12	1,34
				150	2,90	3,48	2,13	2,56
ŽLABOVÝ KOTLÍK		B12	ks	125	4,19	5,03	2,88	3,46
				150	5,00	6,00	4,16	4,99
LAPAČ LÍSTIA pozinkovaný		B13	ks	UNI	-	-	2,99	3,59
ŽLABOVÝ ÚCHYT UNI		B14	ks	UNI	1,00	1,20	0,80	0,96
DOČASNÝ ZVOD fóliový rukáv z PE		B20	bm	UNI	0,25	0,30	-	-
ZVODOVÁ RÚRA L=1000/3000MM		B21	bm	87	4,80	5,76	2,50	3,00
				97	5,10	6,12	3,19	3,83
KOLENO ZVODOVEJ RÚRY 60°		B22	ks	87	4,40	5,28	2,50	3,00
				97	5,30	6,36	3,73	4,48
REDUKCIA		B24	ks	97	4,20	5,04	3,10	3,72
ZACHYTÁVAČ VODY		B27	ks	87	28,60	34,32	27,00	32,40
				97	36,00	43,20	31,50	37,80
ZVODOVÁ ODBOČKA		B28	ks	87	23,55	28,26	17,99	21,59
				97	26,49	31,79	21,38	25,66
OBJÍMKA ZVODOVEJ RÚRY - nová		B26L	ks	87	3,05	3,66	2,70	3,24
				97	3,10	3,72	2,80	3,36
KOMBISKRUTKA S HMOŽ. DO MURIVA				€/MJ bez DPH		€/MJ s DPH		
M8X80/12X60				ks	0,25	0,30		
M8X140/12X120				ks	0,35	0,42		
M8X200/12X180				ks	0,41	0,49		
M8X250/12X180				ks	0,52	0,62		
M8X300/12X180				ks	0,64	0,77		
KOMBISKRUTKA S HMOŽ. DO ZATEPLENEJ FASÁDY - min. zateplenie 100mm								
M8X80/HD2F 12X100				ks	1,29	1,55		
HMOŽDINKA DO ZATEPLENEJ FASÁDY - min. zateplenie 100mm								
HD2F 12X100				ks	1,19	1,43		

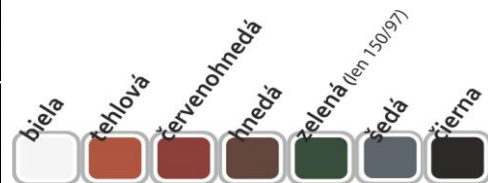
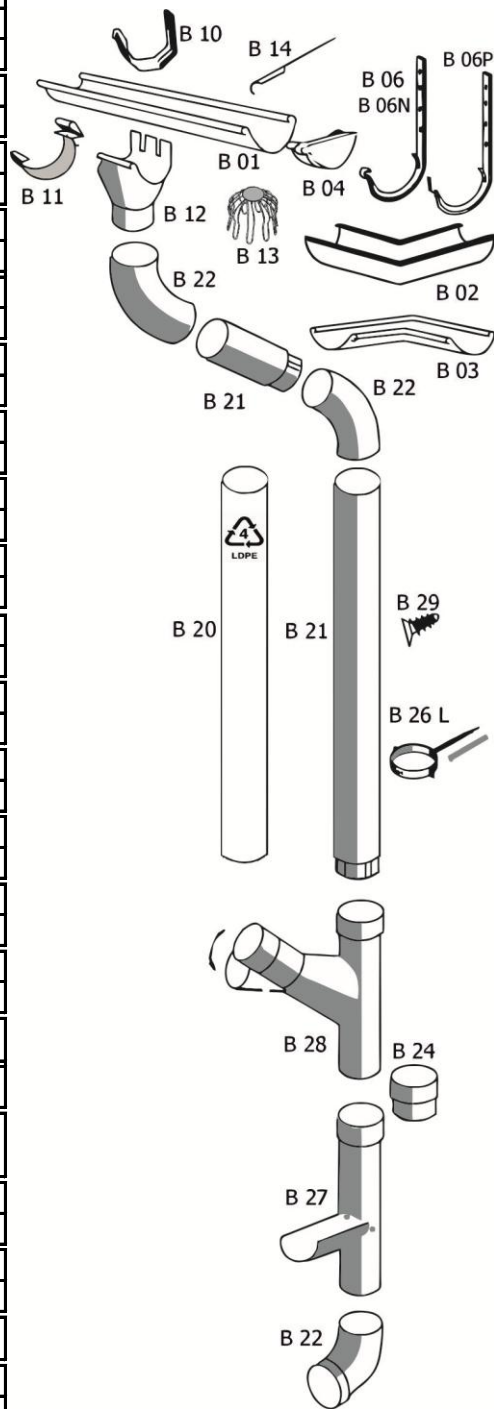

* dopredaj skladových zásob

Cenník platný od 01.03.2019 DPH 20%

MBS STRECHY s.r.o., Sobôtka 5687, Rimavská Sobota,
e-mail: mbsstreachy@mbsstreachy.sk, web: www.mbsstreachy.sk

mob: 0915802398 tel/fax: 0475811306

MBSstreachy
strešné centrum